

Liquid Chromatograph

HPLC-1100



1100 HPLC System

- Engineered using the core competencies of our experience, Agress1100 provides superior data quality, excellent robustness and long-term performance.

Characteristics

- Affordable
- VFD display screen
- Control mode: external/internal
- Easy to use
- Superior repeat-ability

Key Technologies

- Connections University
- Methods Validation Software and System
- Performance Certified Training and Education

Excellent Performances

- 1.The LOD as low as 4x10⁻⁹g/ml**
Mobile phase: Methyl alcohol Flow rate: 1mL/min
Detection wavelength : 254nm RT: 1.0s
Sample: Naphthalene (1x10⁻⁷g/ml)
- 2.Repeatability**
1-uracil, 2-acetophneone, 3-toluene, 4-ethyl benzene, 5-fluorene
Peak area of fluorene: RSD=0.048% Retention time of fluorene: RSD=0.017%
- 3.Baseline Noise**
- 4.Gradient**
- 5.High Resolution**

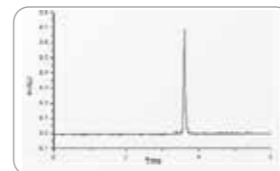

1.The LOD as low as 4x10⁻⁹g/ml

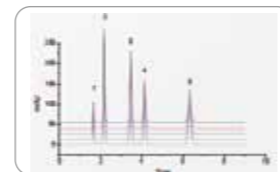

2.Repeatability

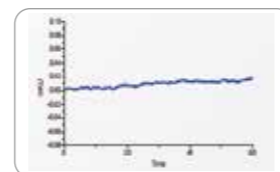

3.Baseline Noise

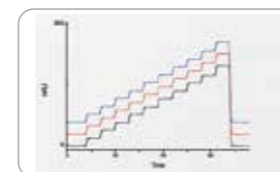

4.Gradient

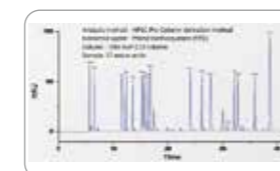

5.High Resolution



Isocratic Systems Configurations

Item	Description	Quantity
1	HPLC-1100FP High Pressure Constant Flow	1 ea
2	Pump	1 ea
3	HPLC-1100DT UV/VIS Detector	1 ea
4	Valco Sample Injector	1 ea
5	HPLC-1100CO Column Oven (alternative)	1 ea
6	BEH HPLC Column	1 set
HPLC-1100ST Workstation		

Binary High Pressure Gradient Systems Configurations

Item	Description	Quantity
1	HPLC-1100FP High Pressure Constant Flow Pump	2 ea
2	HPLC-1100DT UV/VIS Detector	1 ea
3	Valco Sample Injector	1 ea
4	HPLC-1100 GM Gradient Mixer	1 ea
5	HPLC-1100CO Column Oven (alternative)	1 ea
6	BEH HPLC Column	1 ea
7	HPLC-1100ST Workstation	1 set

HPLC-1100FP High Pressure Constant Flow Pump

- 1.Function keys for setting Max. pressure and switching A/B pump
- 2.Decreased fluid pulsation
- 3.Improved stepper motor operation stability by radiating way

Specifications

Item	Description
Flow Rate	0.001-10.000 mL/min (Step: 0.001 mL/min)
Accuracy	±0.3%
Precision	≤0.1% RSD
Max Pressure	42 MPa (6000 psi)
Dimension/Weight	420 mm×260 mm×160 mm/12 kg
Power	AC 220 V, 50 Hz



HPLC-1100DT UV/VIS Detector

- 1.Function keys for wavelength program and D2 Lamp energy
- 2.D2 lamp alarming function
- 3.Casting monochromator framework for improved light path accuracy and sealing efficiency

Specifications

Item	Description
Wavelength	190-700 nm
Noise	$\leq \pm 1.0 \times 10^{-5}$ AU
Drift	$\leq 2.0 \times 10^{-4}$ AU/h
Dimension/Weight	420 mm×260 mm×160 mm/12 kg
Power	AC 220 V ($\pm 10\%$), 50 Hz/100 W

HPLC-1100CO Columns Oven

Specifications

Item	Description
Temperature	R.T.+5 C~99 C
Setting Precision	0.1 C
Control Accuracy	± 0.5 C
Dimension/Weight	120 mm×65 mm×500 mm/8.5 kg
Power	AC 220 V ($\pm 10\%$), 50 Hz



HPLC-1100ST Workstation

- HPLC-1100ST workstation is the classical chromatography data-processing system, with a completely fresh external-connect design hardware (USB port) and software based on Win OS, with up to date software design technology(O-O) and the experiences collection of many experts & clients, all of the above make it to be more functional, and easily-operated workstation.
- HPLC-1100ST is easily operated as MS OFFICE software, such as analysis of complex samples with visual and graphical button line. Call out chromatogram with clipboard under the software of WORD and create a report of pictures & words.
- HPLC-1100ST can accommodate the HPLC system, and any types of chromatography instruments. It is the ideal substitute of integrator, data processor and traditional workstation, so it will be your right hand in your laboratory analysis.

Characteristics

- Simple for use
- Flexibility in data display
- Real-time and fast determination of peak area
- Easy review of entire system
- Real-time operating status and indicator feedback of instrument units
- Easy comparison of multiple chromatograms
- Customizable reports
- Supporting tools for GLP / 21 CFR Part 11—Audit trail of whole system and chromatograms
- User accounts-selectable rights, unique user profiles, allow to create a unique password to protect profiles of each user.

Liquid Chromatograph

HPLC-3100

Perfect Functionality

- An optimized extinction secondary spectroscopy function, which greatly
- improves reliability -Improved heat dissipation efficiency and reduced baseline drift of deuterium lamps
- Chromatography data workstation with stable real-time feedback control of the main status and parameters of each unit module

Stable communication

- Isolated DA output module, which makes the analog signal output more stable, as an optional module, can meet the special needs of customer fraction collection.
- The standard communication method adopts the USB interface with better applicability, selects the imported USB chip and adopts the advanced magnetoelectric/optical isolation technology to ensure the instrument stable
- The RS-485 communication between the unit instruments adopts mature and flexible technology, and uses "avalanche second-ary tube" instead of "TVS tube" to ensure communication reliability. Reliability and stability of instrument control

Excellent performance

- High-pressure constant-flow pump continues the low pulsation to ensure infusion stability
- PID segmentation technology combined with temperature calibration curve and single-point calibration to ensure the accuracy and repeatability of the column temperature chamber.
- Excellent repeatability and linearity of the autosampler.

Humanized design

- Equipped with autosampler can greatly improve the automation level of the whole instrument and the efficiency of customer's analysis
- Optimized location of the detection cell to harmonize with the complete system, facilitating piping connections and reducing out-of-column effects.
- Multi-level fault indication and alarm function, the operator can be informed of the instrument status in time to ensure the safety of man and machine.

Diversified system configuration options

- The building block unit module can flexibly realize isocratic, binary high-pressure gradient, quaternary low-pressure gradient, and DAD system configuration according to customer needs;
- Optional unit modules such as column oven, autosampler, degasser, fraction collector, post-column derivatizer, differential detector, evaporative light detector, laser induced fluorescence detector, etc. can meet different customer needs.



High pressure constant flow pump:

Functional features

tandem double plunger one-piece pump head with a cam stroke of only 2 mm. stepper motor interpolation control technology for improved accuracy and repeatability at low flow rates.

Selected imported high-quality key components to ensure long-term operational infusion stability and durability.

Real-time pressure detection display, high and low pressure alarms and other functions ensure the safety of the instrument's use.

Microcontroller and SPI bus technology, which reduces the size of the board and the number of devices used and increases reliability.

VFD vacuum digital tube 20 x 2 display window, friendly human-machine interface, easy and flexible operation.



Performance indicators

Item	Description
Flow range	0.001~10.000mL/min (Set step size 0.001mL/min)
Flow Accuracy	≤±0.2% (1.000mL/min, 8.5MPa, Water, room temp)
Flow stability	RSD≤0.06% (1.000mL/min, 8.5MPa, Water, room temp)
Maximum working pressure	45MPa (0.001~5.000mL/min) 20MPa (5.001~10.000mL/min)
Lagging volume	≤500μL
Size/weight	420×300×175mm (Length×Width×Height) /12kg
Power supply/power	AC220V±10%, 50Hz/80W

Low pressure quadruple constant current pump:

Performance indicators

Item	Description
Flow Range	0.001-10.000mL/min
Gradient accuracy	≤±1.0%
Maximum working pressure	63MPa
Retention time repeatability	≤0.1%
Communication method	UDP Network Communication
Mixing volume	750μL
Size / Weight	400×300×180mm(Length×Width×Height)/15kg
Power supply/power	AC220V±10%, 50Hz/100W



Low pressure quadruple constant current pump which can be conveniently used with various liquid chromatography detectors, autosamplers, column temperature chambers and other units, or used as an infusion tool alone. Different ratios of mobile phases can be provided for routine applications and method development applications.

Functional features

5mm parallel double plunger, improve infusion stability and prolong solenoid valve life.

5ms high-speed solenoid valve, reduce the opening dead time, reduce heat generation, improve the proportional accuracy.

Symmetrical proportional distribution, so that the distribution is more accurate, 1% step test error are <1%, the flow has better Symmetrical proportional distribution, so that the distribution is more accurate, 1% step test error are <1%, the flow has better repeatability.

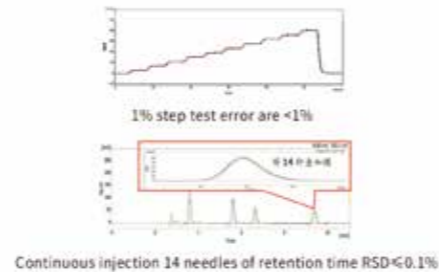

Degasifier:

Functional features

Removing the gas dissolved in the mobile phase by automatic continuous vacuum degassing method with high efficiency.

Adopts stepper motor subdivision control technology to achieve continuous low-speed and high-speed cyclic operation of the pump, avoiding baseline fluctuations, greatly reducing noise and wear and tear.

Adopting imported Teflon® AF degassing membrane, which has good degassing effect, effectively reduces the volume of the inner chamber, and has good chemical resistance.

Compact design, small size and easy to use with any HPLC connection, is the ideal complementary product for HPLC.



Performance indicators

Item	Description
Online degassing	Built-in binary quaternary
Maximum flow rate of single channel	10.000mL/min
Deaeration fluid channel inner diameter	1.143mm
Standard channel volume	480µL/channel
Contact with liquid materials	PEEK, Teflon® AF
Size / Weight	250×95×155mm (Length×Width×Height) /1.5kg
Power supply/power	AC220V±10%, 50Hz/20W

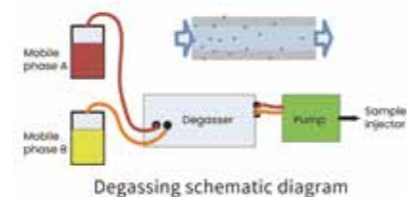

UV-Vis detector:

Functional features

A more aerodynamic vertical air duct design that goes right to the heart of the heat source.

Lower baseline drift, less baseline noise. -A time-wavelength program function.

New design of the test cell shape and mechanical structure, compact. -Addition of DA analogue output function for detectors (optional)

Dual wavelength mode provides simultaneous chromatograms at two wavelengths.



Performance indicators

Item	Description
Wavelength range	190~700nm
Baseline noise	≤±0.5×10 ⁻⁵ AU (Dry pool- 254nm)
Baseline drift	≤1.0×10 ⁻⁴ AU/h (Empty pool- 254nm- 20Hz)
Size/weight	420×300×175mm (Length×Width×Height) /16kg
Power supply/power	AC220V±10%, 50Hz/100W

Diode array detectors:

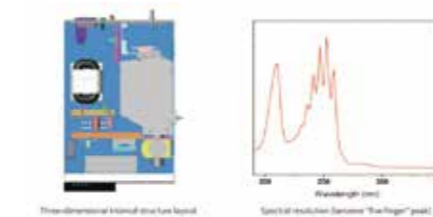

Functional features

Possessing the patent of "Anti-dipole Spectrometer for Chromatograph";

The internal structure of photoelectric isolation and stable and reliable heat dissipation technology;

The product is integrated into the chromatography data workstation, with complete analysis automation and audit tracking functions;

It can realize multi-channel wavelength detection, controllable acquisition frequency and wavelength range, spectral library retrieval, peak purity calculation and other advanced functions to meet user detection needs.

Performance indicators

Item	Description
Wave length range	190~800nm
Baseline noise	≤±1.0×10 ⁻⁵ AU
Baseline drift	≤2.0×10 ⁻⁴ AU/h
Size/weight	420×300×175mm(Length×Width×Height)/18kg
Power supply/power	AC220V±10%, 50Hz/80W

Chromatography Data Workstation:



The Kromstation chromatography data workstation is the workstation software for LC systems CNAS certified. With Kromstation can control liquid chromatography and complete various operations with a personal computer, with superb database, audit trail, GLP. Data archiving and backup, electronic signature, permission setting, networked management, etc.; the interface is simple and easy to use in the process.

Functional features

Optional software with audit trail version (audit trail and electronic signature comply with CFDA data integrity management regulations) or software without audit trail version.

System management functions to meet the security requirements of various workflows.

Provides multi-level access management and electronic approval of analysis data stored in the database

Detailed user information can be saved to create a review history that manages appropriate reviews.

Customised reports are available, combining many different items.

Autosampler:

Performance indicators

Item	Description
Sampling range	0-100 μ L (Incremental 0.1 μ L)
Number of samples processed	120 bits
Sample residues	< 0.01%
Sampling repeatability	RSD < 0.3% (Full ring injection, 20 μ L sample ring)
	RSD < 0.5% (Part volume with sample loss injection)
	RSD < 1.0% (Part volume with sample loss injection)
Size/weight	540 \times 400 \times 300mm (Length \times Width \times Height) /23kg
Power supply/power	AC220V \pm 10%, 50Hz/30W



Functional features

Improved positioning accuracy with 8-bit position calibration

Relative movement of the tray and sample needle to shorten the injection cycle. -New injection mode with greatly optimised line connections

Unique sample needle design to avoid the problem of clogged sample needles. -Excellent mechanical precision and stability.

Independent software control, compatible with a wide range of HPLC models.

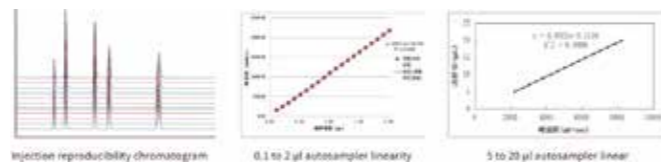

Chromatographic column thermostat:

Performance indicators

Item	Description
Temperature control range	Room temperature is above+5~80 C
Room temperature is above+5~80 C	\leq 0.1 C
Size/weight	420 \times 300 \times 120mm (Length \times Width \times Height) /7kg
Power supply/power	AC220V \pm 10%, 50Hz/130W



Functional features

Advanced 32-bit ARM processor in the main control chip, faster computing speed and higher integration

AC phase modulation, combined with temperature, calibration curve and single point correction, ensures accuracy and reproducibility of temperature within the set range and shortens temperature stabilisation time to less than 30 minutes

Embedded software introduces digital PID algorithms for shorter temperature rise and stabilisation times and smaller temperature rushes



Temperature linear gradient curve

Solvent Controller:

Solvent controller is a magic tool developed realize the problem of solvent switching in liquid chromatography. It can complete the binary / ternary / quaternary solvent switch with One click and realize unattended automatic sequence analysis and improve the efficiency of the instrument during working hours. The Solvent controller can be used with any set of liquid chromatographs to realize the upgrade match as you like.

Performance indicators

Item	Description
Flow Range	\leq 10mL/min
Switching speed	\leq 100ms
Inner chamber volume	\leq 40 μ L
Maximum withstand pressure	0.3MPa
Communication method	UDP
Liquid contact material	316L/PFA/FFKM



Functional features

Long press for 1 second to easily switch the flow path manually, making flushing convenient and fast.

Automatically memorize the flow path state when the power is turned off last time and switch to this flow path directly.

Automated sequence analysis between different mobile phase conditions when unattended.

Fast completion of binary, ternary and quadratic switching of isocratic/gradient, with 63% increase in work efficiency.

Support sequence number identification and multiple control.

Liquid Chromatograph

HPLC-6000

Description

- More advanced technology
- More stable performance
- More reliable use
- More flexible configuration

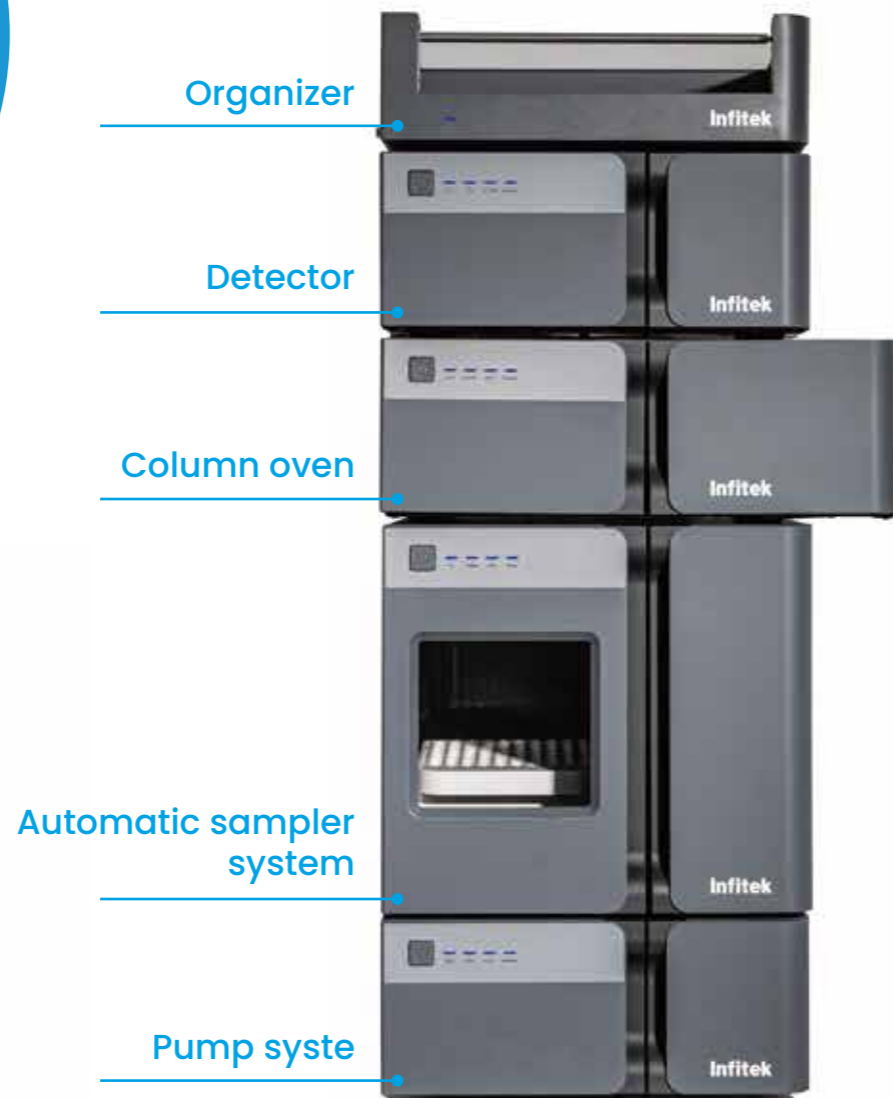

Pump System

Higher precision, Lower pulsation and Excellent stability

The four element pump system achieves high-frequency mixing of the gradient system, reduces the generation of solvent mixing bubbles, reduces infusion pulsation, and ensures infusion accuracy and stability.

HFM high frequency hybrid mode

By increasing the switching frequency of proportional valve, the mixing accuracy of mobile phase is improved. The sufficient mixing of solvent can be ensured without large volume mixer, which greatly reduces the system delay volume and baseline noise of the system.

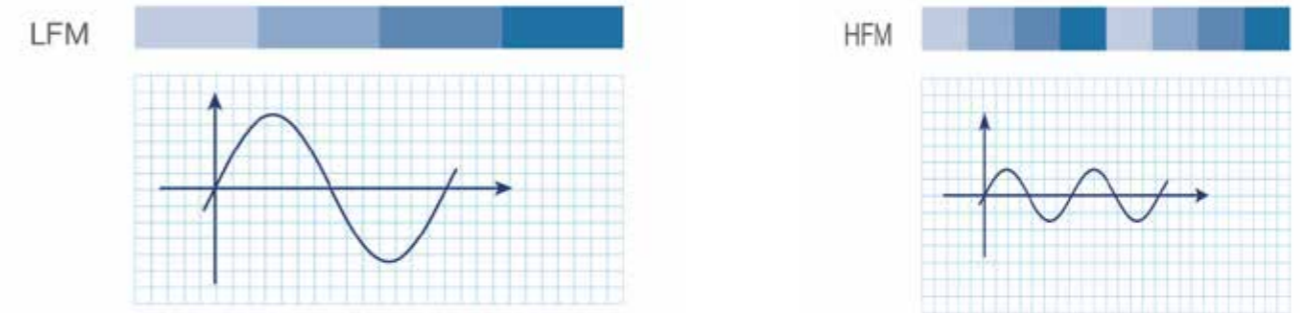

Special curve cam design

The special curve cam is used to drive the plunger to make the infusion more stable and lower pulsation.

High speed feedback and real-time control

Through real-time monitoring the pressure of the system, adjusting the motor speed, and equipped with special curve cam transmission, the infusion pulsation can be further reduced while ensuring the stability of flow.

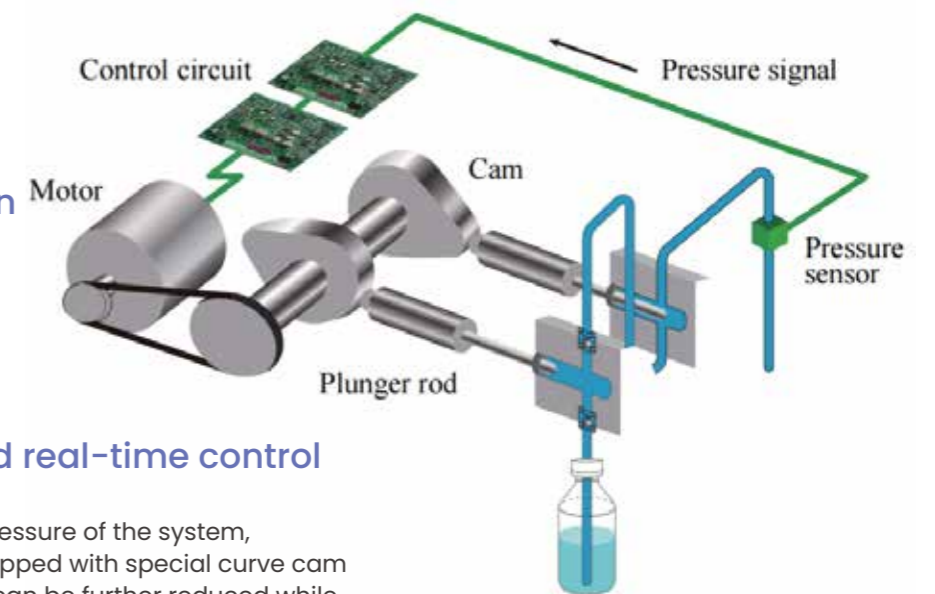

Cascade inlet and outlet valve core design

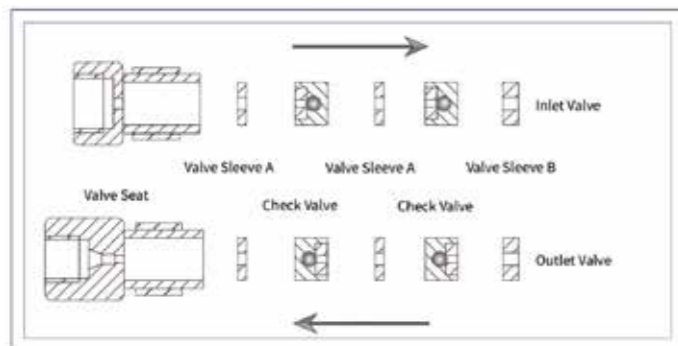

The two-stage series valve core of the inlet and outlet valve ensures the stability of infusion and reduces the pulsation of the pump system.

Rich options and easy maintenance



The sealing ring of the pump, the sealing ring of the cleaning device, the one-way valve and the plunger rod can be directly replaced in front of the pump, which is convenient for maintenance. The degassing device and gradient unit are built-in to realize a simple and tight paint appearance.

Excellent retention time reproducibility

Sample: Alkylphenol compounds (9 components)

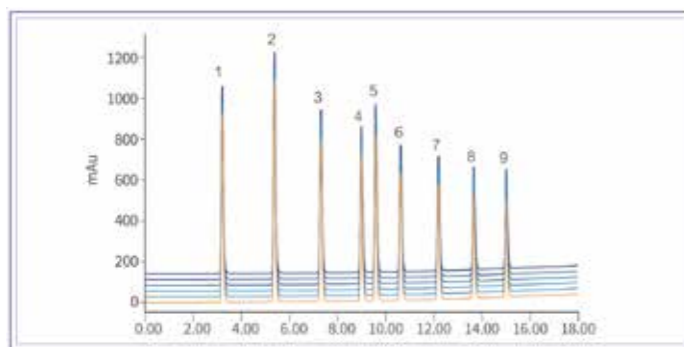

Peak number	Sample	RT(min)	RT(%RSD)
1	acetanilide	3.220	0.03
2	acetophenone	5.397	0.04
3	phenylacetone	7.328	0.03
4	phenylbutanone	9.006	0.02
5	benzophenone	3.593	0.02
6	phenylpentanone	10.642	0.02
7	benzophenone	12.214	0.02
8	phenylheptanone	13.679	0.02
9	octyl benzene	15.026	0.02

Cascade inlet and outlet valve core design

Chromatographic conditions	
Sample: alkylphenol Compounds (9 Components)	HFM Gradient Mode:high Frequency Mode HFM
Column: C18 4.6x150mm(5μm)	Gradient: a:b (Min)=65:35(0)→5:5(15)→5:95(20)→65:35(20.1)→65:35(30)
Temperature: 40 °C	
Mobile Phase:	Injection:10ml (100ppm)
A Water + 0.1% Trifluoroacetic	
B Acetonitrile + 0.1% Trifluoroacetic Acid	

Automatic Sampler System

Lower residue, Higher precision and Excellent reproducibility.

Rich options and easy maintenance

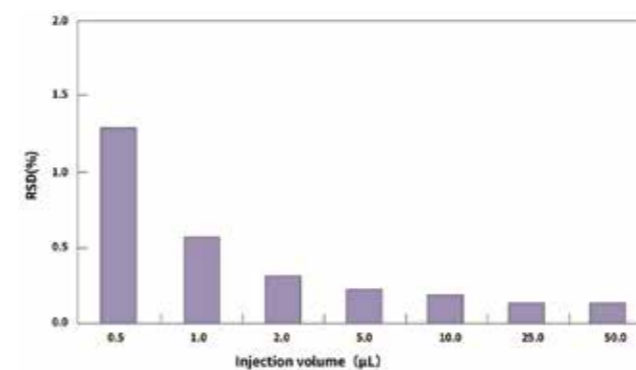

The direct injection method combined with the improved design of a new high-precision injection driving unit ensures the accuracy and repeatability of the injection.

- 1.FTN injection method
- 2.Surf style needle outer wall cleaning
- 3.Needle washing solution not to be reused

Low sample residue

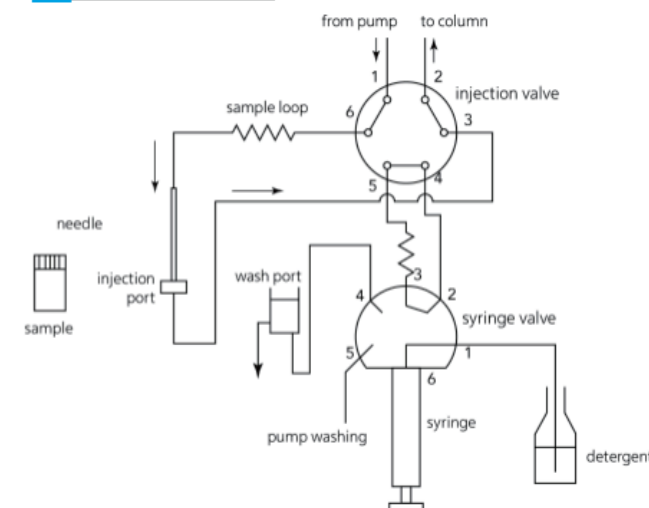

Reduce sample waste, reduce sample residue and improve injection reproducibility;

Improving the injection speed is beneficial for high-throughput sample analysis;

The optimized injection system cleaning method further reduces sample residue.

Sampler with thermo rack (optional)

The system uses Peltier temperature control module to accurately stabilize the temperature of the sampler at the set value and ensure the stability of temperature sensitive samples.

For temperature sensitive samples, the sample analysis is carried out without the temperature control of the injection system. The increase of external temperature will lead to the generation of impurities, and the impurities will gradually increase and become larger.

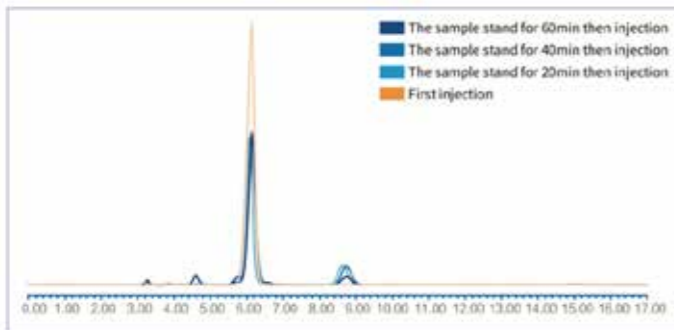
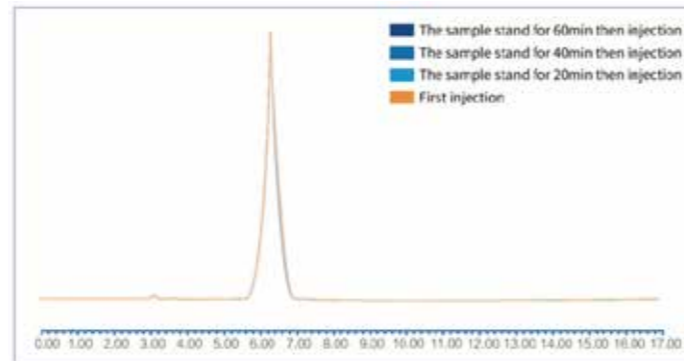

For the same sample, the sample was analyzed at 4°C in the sampling system, and the analysis results did not change with the passage of time.

Humanized sample rack design

The inner part of the instrument is designed to prevent condensation and improve the service life of the instrument.

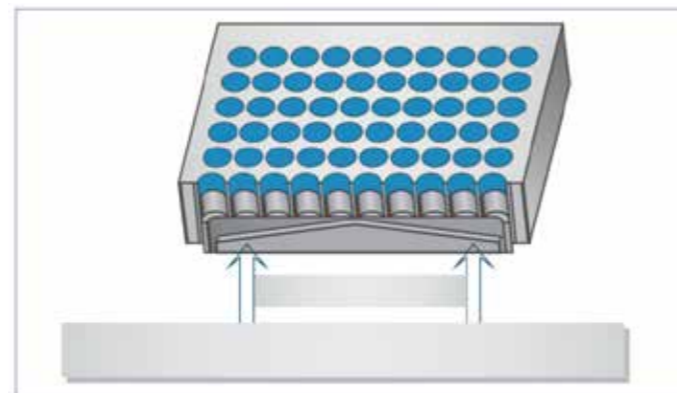

Column Oven

More accurate temperature control accuracy;
Wider temperature control range;
More flexible column management;

The column temperature box adopts a Peltier temperature control unit and a specially designed preheating function to ensure sharp, symmetrical, and reproducible chromatographic peaks.

Peltier temperature control mode

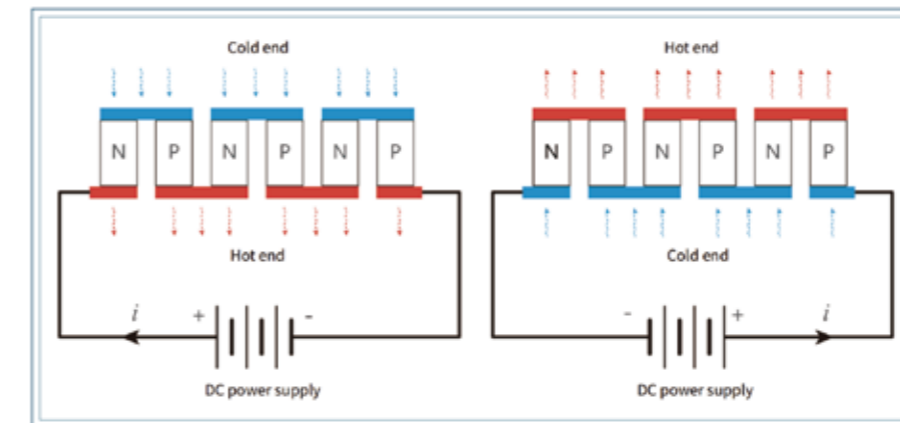

Capable of simultaneously heating and cooling, providing a wider temperature control range.

Mobile phase preheating function

The mobile phase is preheated before entering the column to reduce the interference to the temperature environment in the column;

The air inside the column oven always circulates to ensure the constant ambient temperature around the column;

Ensure that the internal temperature of the chromatographic column is constant during the experiment.

Air circulation mode

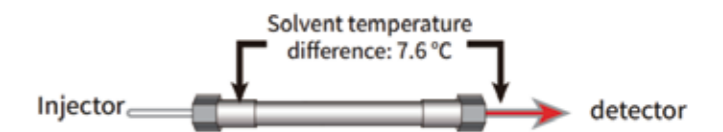

Air circulation + Preheating mode

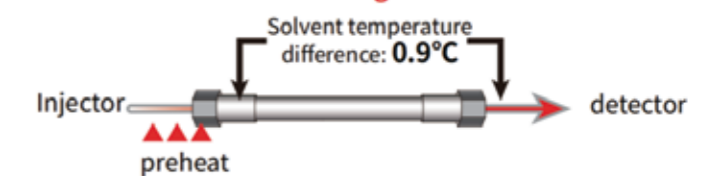

Optional valve

Column switching valve: three chromatographic columns can be placed at the same time. Through the three column switching valve, the flexible switching between chromatographic columns can be realized, which is convenient for method development and column screening.

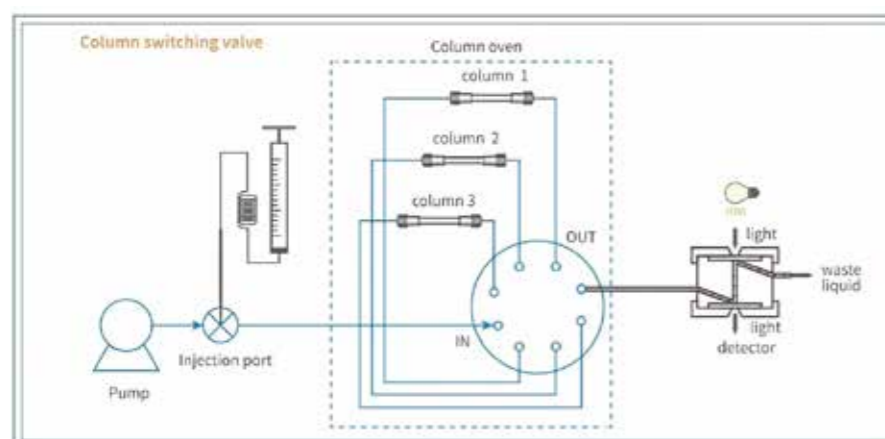

Column switching valve: three chromatographic columns can be placed at the same time. Through the three column switching valve, the flexible switching between chromatographic columns can be realized, which is convenient for method development and column screening.

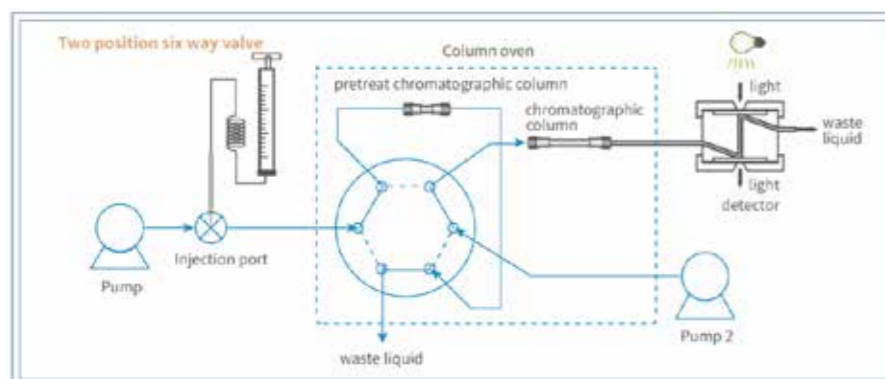

Two position six way valve: it can meet the experimental needs of a variety of chromatographic methods, such as online sample processing, online enrichment, two-dimensional chromatography, etc.

A Variety of Detectors with Excellent Performance

A variety of detectors can be selected to meet the different needs of users.



UV Detector

Adopting high-quality optical units and optimized optical path design, it can provide higher sensitivity and meet the analysis of trace and trace samples.

DAD

The sensitivity of DAD detector reaches the level of UV detector which can meet the needs of high sensitivity analysis and purity analysis at the same time.

- 1.High quality optical units
- 2.Optimized optical path design
- 3.1024 diode array
- 4.Mechanical engraved grating

Liquid Chromatograph

HPLC-W3200

High-Performance Liquid Chromatography System

Features a mainstream modular design, providing a comprehensive suite of system monitoring functions to meet a broad range of detection requirements.

Incorporates custom-designed, acetonitrile-resistant check valves.

Equipped with a newly designed cam profile that uses electronic pulsation suppression and solvent compression compensation technology, significantly reducing pressure fluctuations and ensuring higher reproducibility of results.

Built-in online cleaning function for the plunger rod.

Equipped with a 1800 lines/mm grating.

Offers options with UV, ELSD (Evaporative Light Scattering Detector), FLD (Fluorescence Detector), DAD (Diode Array Detector), and RID (Refractive Index Detector).

Integrates a fully intelligent chromatography workstation.

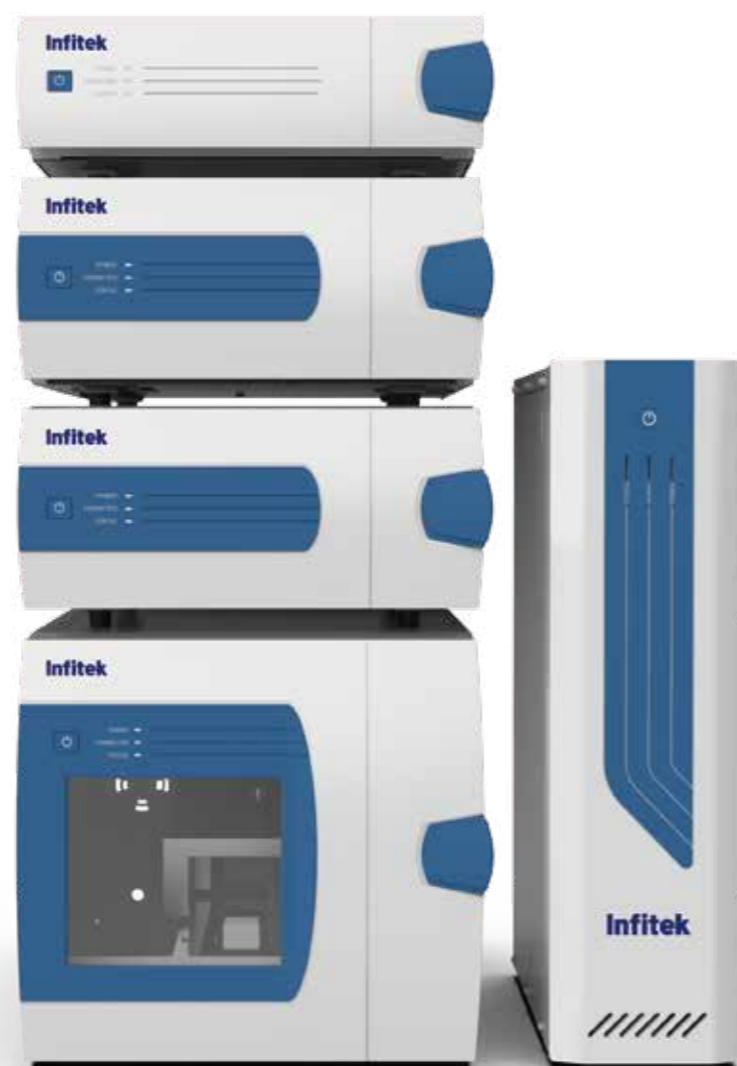

Full Range HPLC-W3200



Automatic Sampler

The auto-sampler seamlessly integrates with the workstation and incorporates globally sourced, premium components. Its high-precision metering pump significantly enhances the accuracy of sample injections. Employing a polar coordinate design and XYZ three-dimensional movement, it offers multiple selectable injection methods to accommodate diverse client needs. Equipped with an auxiliary air pump, it supports cooling mode selection and features an intelligent lighting design for convenient observation.

P Pump

Optional configurations include isocratic pumps, binary pumps (with 2 or 4 solvents), and quaternary pumps.

The custom high-precision gradient valve is installed to ensure exceptional gradient repeatability.

Employing secondary suspension technology in the high-pressure constant flow pump, it increases the overall system lifetime and reduces wear on seal rings, ultimately saving customers on operating costs.

An integrated degasser caters to the degassing needs of both the high-pressure pump and the autosampler's cleaning solvent.

C Column Oven

Bidirectional heating and cooling forced-air temperature control ensures precise temperature, uniform heat distribution, and high stability.

Provides either 2 positions for installing "250mm column + guard column" or 4 positions for "150mm column + guard column", accommodating the vast majority of user requirements.

Capable of integrating switching valves to support complex applications such as two-dimensional chromatography and online preprocessing.

W Workstation

Equipped with both local and network deployment capabilities to cater to the needs of users of varying scales.

The Smart Lab CDS adopts a database storage model, providing audit trail, multi-level access control, and versatile data processing features, meeting the requirements of GMP and FDA 21 CFR Part 11.

Full Range Liquid Chromatography Detectors



Diode Array Detector (DAD)

The Diode Array Detector is an integral part of high-performance liquid chromatography systems, characterized by its highly efficient, integrated optical design. It offers stable and reliable performance, allowing for simultaneous detection across a wavelength range of 190nm to 800nm. Beyond traditional chromatographic functions, it provides several unique features such as spectral diagrams, matching calculations, 3D views of maxima plots, contour line graphs, peak purity calculations, and spectral library management. This versatility makes it a powerful tool for comprehensive analysis and identification in liquid chromatography applications.

Ultraviolet Detector

Light Source: Dual-lamp design allows for the optional use of both a deuterium lamp and a tungsten lamp, providing a wavelength range of 188-900nm.

Flow Cell: A novel flow cell design incorporating polished optical paths and an ultra-low post-column dead volume contributes to improved system column efficiency. **Dual Wavelength Detection:** Capable of simultaneous detection at two separate wavelengths.

Wavelength Scanning: Permits scanning of the absorption spectrum across the full wavelength range of the light source.

Leak Detection: An alarm system is in place to alert when leaks occur due to incorrect operation or over-pressure conditions.

In-Unit Automatic Spectral Calibration: Based on grating dispersion theory and the characteristic spectral light of the deuterium lamp, the instrument incorporates a simple and accurate spectral calibration algorithm for consistent performance.



Fluorescence Detector

The fluorescence detector employs a DC xenon lamp as its light source, featuring a dual monochromator design that allows for flexible adjustment of both the excitation and emission wavelengths to meet the diverse detection needs of various sample types.

Equipped with both a touch-screen LCD display and chromatography workstation operation modes, it offers dual analog channel outputs and supports data transfer via RS232 serial port or Ethernet connection.

Suitable for the detection of a wide variety of substances, including polycyclic aromatic hydrocarbons, hydrocarbons, aflatoxins, vitamins, amino acids, etc.



Refractive Index Detector (RID)

Long-life LED light source ensures extended instrument lifetime.

A stable temperature control module maintains minimal signal drift through consistent heating.

A high-sensitivity photoelectric liquid leakage alarm promptly alerts operators to any abnormal working conditions.

The instrument supports both digital protocol output and analog signal output modes, making it fully compatible with various liquid chromatography systems.

A 7-inch full-touch screen provides an intuitive and user-friendly interface for effortless operation.



Evaporative Light Scattering Detector (ELSD)

Low-temperature evaporation design caters to the detection of thermally unstable substances.

An innovative split-flow mode expands the application scope of the evaporative light scattering detector.

Independent control of nebulization, evaporation, and detection airflow streams adapts to the analysis of materials with diverse characteristics. High-performance photomultiplier tubes guarantee exceptional sensitivity.

A 7-inch full-touch screen simplifies operation and enhances user convenience.

Liquid Chromatograph

HPLC-W3400

Features

1. Rapid Separation Liquid Chromatography (RSLC) System

- ◆ Separable Modular Structure: Multiple RSLC main unit models available for customizable configurations.
- ◆ Comprehensive Detector Range: Includes UV, DAD, FLD, ELSD, and RID detectors with intelligent control.
- ◆ Smart Lab Workstation: Simplifies complex tasks with user-friendly interfaces.
- ◆ Chromatography Consumables: Can be selected as needed.

2. Needle-in-Flow Injection System

- ◆ Flow to Needle Injection System: Eliminates sample loss and minimizes cross-contamination.
- ◆ Advanced Online Functions: Supports online derivatization, dilution, and enrichment.
- ◆ Optimized Needle Cleaning: This design reduces contamination risk.
- ◆ Global Standard Performance: Ensures better qualitative and quantitative reproducibility.

3. Extended Functions to Meet Diverse User Needs

- ◆ Enhanced Compatibility: Innovative one-way valve technology ensures acetonitrile compatibility.
- ◆ Column oven with valve switching, providing 2 installation clips for 250mm HPLC columns, expandable to 4+ columns.
- ◆ Innovative Technology: Effectively identifies shoulders and small peaks with guided operation and intelligent integration.



Full Range
HPLC-W3400

Key Components



High-Pressure Pump

- ◆ Maximum Pressure and Compatibility: Capable of withstanding up to 75MPa, compatible with smaller particle size chromatographic columns, enabling seamless method transfer.
- ◆ Acetonitrile-Resistant Valve: Features a high-precision, self-restoring, acetonitrile-resistant one-way check valve, ensuring stable fluid delivery in acetonitrile applications. The further optimized two-stage floating technology significantly reduces wear on highpressure seals, extending the lifespan of consumables.
- ◆ Flow Stability and Gradient Accuracy: Proprietary fluid compression compensation technology with real-time feedback electronic pulsation suppression control ensures stable flow and precise gradient accuracy.
- ◆ Quaternary Pump with Degassing: Quaternary pump integrated with 5-channel degassing (A, B, C, D, AS).
- ◆ Binary Pump with Solvent Switching: The binary pump comes with a standard solvent switching valve, enabling binary and four-way expansion for analysis.
- ◆ User-Friendly Design: Equipped with a touch panel switch, meeting the needs for offline operation and human-machine separation.



Auto sampler

- ◆ Needle-in-flow design ensures zero sample loss during injection.
- ◆ Compatible with different specifications of sample trays, expanding user application scenarios.
- ◆ Metering pump for precise sampling, offering longer lifespan and higher accuracy compared to syringe pumps. ◆ Optimized needle cleaning flow path minimizes cross-contamination, ensuring sample purity.
- ◆ Standard obstacle protection function effectively prevents damage to the injection needle.
- ◆ Standard empty bottle detection function to prevent invalid sample injection.
- ◆ Full range of sample pretreatment functions supporting online enrichment, online derivatization, online dilution and mixing, further expanding user method development scenarios.
- ◆ Optional refrigeration component to ensure detection accuracy of thermally unstable substances.
- ◆ Optional condensation peristaltic pump active drainage function to effectively prevent damage to the equipment from overflow of condensation accumulation.
- ◆ Pump and autosampler can be linked for purge operation, eliminating the need for manual purge valve operation.



Column Oven

Default configuration with semiconductor cooling module and electric-resistive heating module, achieving full temperature range control with heating and cooling functions. Two control modes ensure longer lifespan and higher reliability of temperature control components.

Forced air circulation for precise and uniform temperature control throughout the chamber.

Standard preheating module with the same temperature range as the set temperature to ensure optimal temperature consistency.

Multi-column capacity design supporting up to 3 chromatographic columns of 300mm.

Supports upgrade to 2D configuration with built-in high-pressure switching valve, and can be expanded to support multiple external switching valve.

Optional chromatographic column GLP information recording function.



Refractive Index Detector

Designed with a two-chamber configuration and upgraded to a long-life LED light source for maintenance-free operation over its lifetime.

Freely switchable between entry and exit of rinse modes for automatic rinsing of the reference flow cell.

Utilizes a high-precision data acquisition system with sequential rinsing, polarity control, and temperature control.

Imported PD tube ensures high sensitivity.

Equipped with temperature and leak detection alarms for real-time monitoring of instrument status.

Features a touch-sensitive LCD display supporting both local user control and chromatography software workstation modes.

Supports analog and digital signal outputs, compatible with chromatography systems from other brands.

Full Range of Liquid Chromatography Detectors



Diode Array Detector

Capable of acquiring chromatographic signals across all wavelengths from 190 to 800nm, exhibiting detailed spectral structures.

Features a high-intensity deuterium lamp, concave holographic grating, 1024-element photodiode array, and all-solid-state, highly stable optical path structure.

Provides three-dimensional spectra, contour plots, chromatograms, spectra, maximum intensity plots, and other information to support multiple application needs, including advanced functions such as peak purity calculations.

Achieves extreme low signal noise and drift through independent chamber temperature control, active fan speed control, and passive temperature stabilization of internal materials.



Ultraviolet Detector

Dual-lamp design with a high-transparency deuterium lamp and an optional tungsten lamp, greatly extending the detector's detection range and enabling full-range detection from 188nm to 900nm.

Built-in multi-dimensional wavelength calibration functions (including holmium oxide, potassium dichromate, erbium perchlorate, and deuterium lamp characteristic wavelength calibration) for extremely high wavelength accuracy.

Capabilities include flow-stop spectra scanning, dual-wavelength detection, and wavelength programming.

Supports proportional chromatogram analysis and aids in extended peak purity analysis.



Fluorescence Detector

Dual monochromator structure allows flexible setting of excitation and emission wavelengths, simultaneously monitoring four wavelength channels.

Supports multiple scanning modes including laser spectral scanning, emission spectral scanning, and lamp spectrum scanning.

Provides a stable light source with a direct-current xenon lamp, and multi-level precision detection gain settings for a large dynamic range and high signal-to-noise ratio.

Features a touch-sensitive LCD display supporting both local user control and chromatography software workstation modes.

Supports analog and digital signal outputs, compatible with chromatography systems from other brands.



Evaporative Light Scattering Detector

Designed for low-temperature evaporation, offering high sensitivity for thermally unstable and semi-volatile compounds.

Built-in gas mass flow meter with capillary heat transfer differential calorimetry for precise gas flow control. Independent flow control for nebulization, evaporation, and detection ensures excellent response reproducibility.

Drift tube features corrosion-resistant treatment and stainless steel construction (excluding fragile glass and easily corroded components).

Imported nebulizer and photomultiplier tube ensure high signal sensitivity, long lifespan, and wide adjustable range.

Equipped with temperature, leak, and gas leakage detection alarms for real-time monitoring of instrument status.

Features a touch-sensitive LCD display supporting both local user control and chromatography software workstation modes.

Supports analog and digital signal outputs, compatible with chromatography systems from other brands.

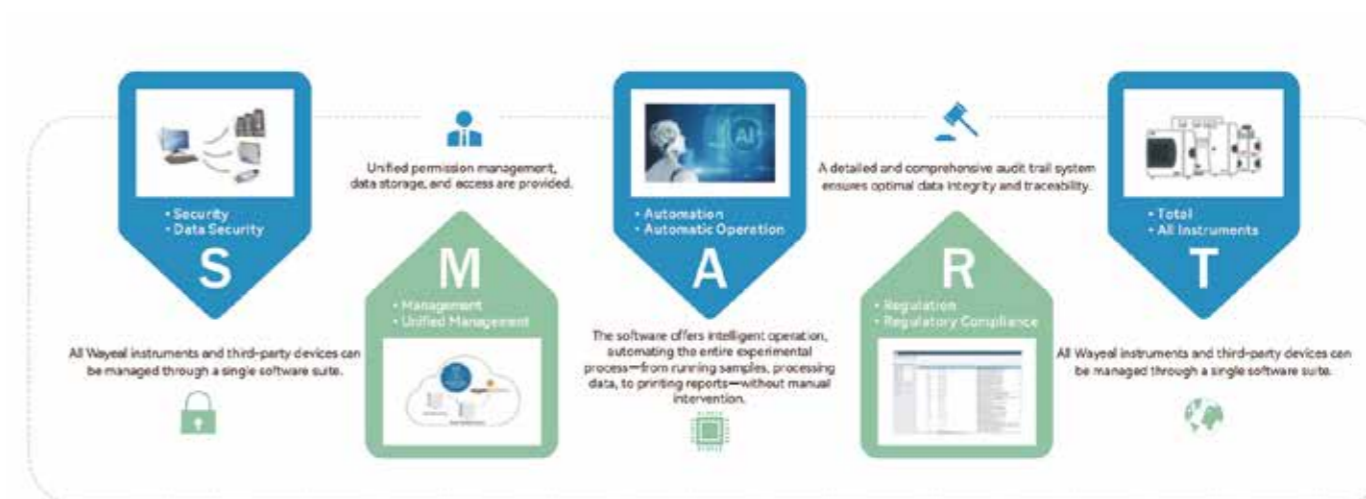

Smart Lab Chromatography Workstation

1. Validated at CMMI Maturity Level 5, which ensures international quality standards for software development.

2. Featuring a comprehensive audit trail function compliant with GMP, CGMP, 21 CFR Part 11, ICH guidelines, and other laws and regulations, ensuring full-process data traceability. Audit trail records are not allowed to be edited and deleted and can be printed.

3. Convenient data organization and storage capabilities, utilizing an efficient database system to safeguard user data security. Automatic backups and cyclic updates ensure complete backups within the latest 7 days, preventing data loss.

4. Features the SmartPeak intelligent peak detection function, and employing a second-order algorithm combined with Gaussian, exponential, and tangent skimming to achieve effective identification and intelligent selection of chromatographic peaks (screenshots of shoulder peak recognition and advanced skimming software provided). This simplifies the integration process, providing consistent and reliable peak detection across multiple chromatograms.

5. Modularized device components enable integration with third-party manufacturers. Full control capabilities for multi-brand and multi-model instruments provide ample scalability for future laboratories.

Liquid Chromatograph

- HPLC-2025 HPLC-2025P1 HPLC-2025P2 HPLC-2025P4
- HPLC-2025AS HPLC-2025CO HPLC-2025UVD HPLC-2025DAD
- HPLC-2025FLD HPLC-2025ELSD HPLC-2025WS

Description

The HPLC-2025 Liquid Chromatograph is a product with higher quality, more reliability and accuracy.

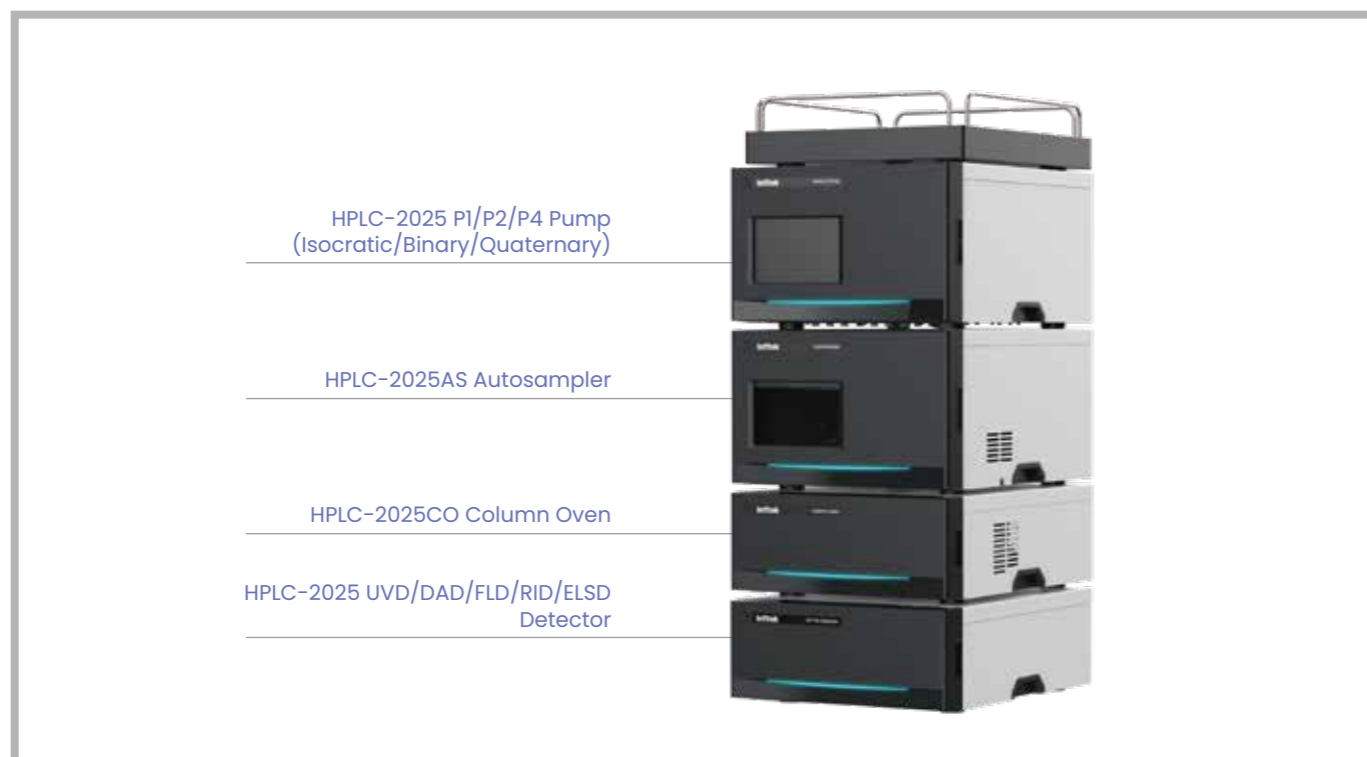

HPLC-2025P1/P2/P4 Pump



P2 Binary pump



P4 Quaternary pump

Specification

Model	HPLC-2025P1	HPLC-2025P2	HPLC-2025P4
Flow Rate Range	0.001mL/min~10.000mL/min		
Pump Type	Isocratic(P1), Binary(P2), Quaternary(P4)		
Maximum Pressure	62MPa		
Plunger Rinsing	Supported		

Precision

Excellent repeatability

The precise gradient change and retention time are guaranteed with the reciprocating tandem plunger pump and pressure dynamic suppression algorithm. The repeatability of retention time is less than 0.2%.

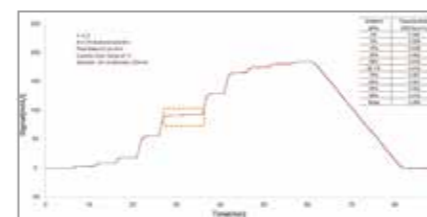

Gradient test

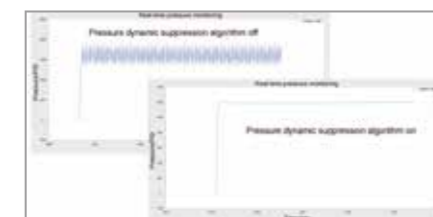

Pressure fluctuation test

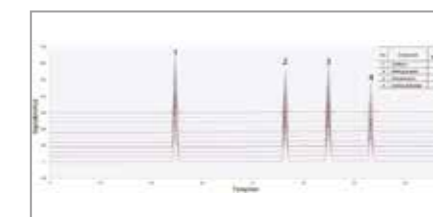

Retention time repeatability test

Reliability

With the reliable design and high-quality components, HPLC-2025 can operate in good condition for a long time

Precision

The precision and accuracy of the results are guaranteed with the pumping and sampling technology, high sensitivity detector, and powerful data processing software.

Ease of use

The operation is more convenient and efficient with a variety of user-friendly designs.

Reliability

The reliable design makes service life longer

Material

The cam is integrally processed from high-hardness alloy steel and combined with high-frequency heat treatment technology, which makes the surface of the cam is more wear-resistant (the hardness is above 55HRC), and the service life is longer.

Power

The high-power customized motor, NSK bearings, and independent air duct make the power and life even better.

Gearing

Self-lubricating and wear-resistant materials are used for the piston drive mechanism. Also, the inner wall rifling design prevents the piston from accidentally locking, making the gearing more reliable.

Plunger

The suspended floating plunger can adapt to the working conditions automatically, which is convenient for disassembly and prevents the eccentric wear of the sealing ring effectively. With the special sealing structure and the automatic cleaning of the plunger, the pump seal is more reliable.

Ease of use



Equipped with an online automatic rinsing mechanism.

When the pump is working, the rinsing pump is automatically turned on and runs periodically, which can effectively prevent the crystallization of buffer salts and the growth of microorganisms, and prolong the service life of the plunger and plunger sealing.

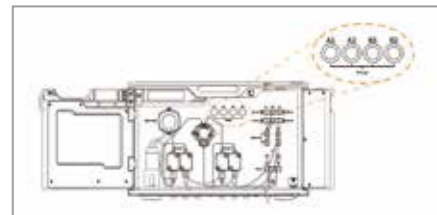

Easy to purge

Both the workstation and the instrument panel are equipped with a purging function, making it easier to purge.

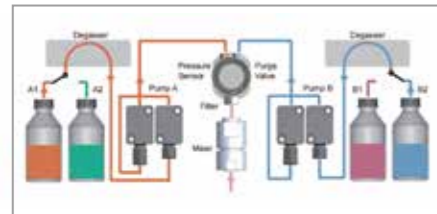

Intelligent solvent switching to improve efficiency

Equipped with a 4-channel solvent selection valve for binary pump. The solvent can be automatically switched according to the method.

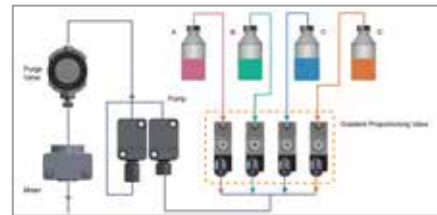

Independent 4-channel gradient proportioning valve, easy for maintenance

The gradient proportioning valve of the quaternary pump adopts a 4-channel independent design. The intelligent monitoring and diagnosis can realize real-time monitoring and independent replacement of each channel, the whole design can reduce maintenance costs effectively.

HPLC-2025AS Autosampler

Specification

Model	HPLC-2025AS
Sample Capacity	108, 2mL(96&384 well plates)
Injection Range	0-100μL
Injection Mode	Low-loss, microliter carrying, full-loop
Injection Time	Minimum to 5 s
Carryover	0.003%
Degassing Unit	Online degassing(optional)
Temperature Control	4-40 °C (optional)

Precision

Precise injection volume

The autosampler adopts an integrated constant pressure needle and a precise syringe pump, which ensures accurate injection volume and excellent linearity, making the results more precise and accurate.

Low carryover to make results more accurate

The sampling needle is highly polished for the outer surface and passivated for the inner surface, which can effectively reduce the sample residue. The carryover is much lower when needle washing of the outer and inner surfaces are performed.

Reliability



Design of needle

With our integrated constant pressure sampling needle, the air pressure inside and outside the sample bottle can be balanced during sampling; the injection port is set on the sidewall to prevent bottle pad debris from clogging the needle during puncture.

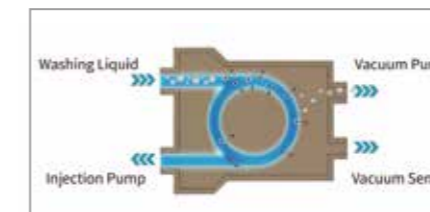

Design of degassing unit of washing liquid

The built-in autosampler degassing unit can be used for degassing of washing liquid, avoiding interference caused by air bubbles.



Design of self-compensation injection pump

The maintenance-free self-lubricating guide device and self-compensating sliding screw are used for real-time compensation of the slight wear, and it has excellent motion accuracy and is more durable.

Ease of use

Preloaded sample injection mode, the injection time can be shortened to 5s, which greatly improves the efficiency.

A variety of injection modes combined with sample temperature control technology to satisfy different detection needs such as rare and unstable samples. The dehumidification function is optionally equipped to avoid the generation of condensed water, effectively prevent the sample from being diluted, and ensure accurate results.

The maintenance is more convenient and efficient with the in-front injection valve.

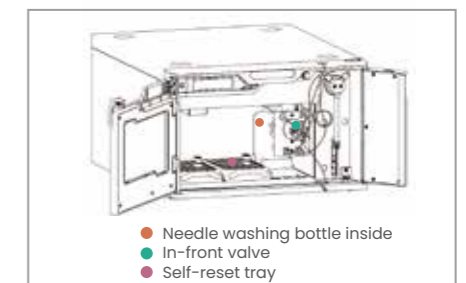

HPLC-2025CO Column Oven

Specification

Model	HPLC-2025CO
Operating Principle	Peltier element and fan-based forced air
Temperature Range	5 °C above ambient to 85 °C 10 °C below ambient to 85 °C

Features

Precision

Precise temperature control ensures good separation and repeatability.

Using fuzzy PID intelligent temperature control algorithm, fan-based air circulation, and multiple insulation layer design, the column temperature is more accurate, stable, and uniform, the temperature stability is ±0.1 °C, and the temperature for each analysis are constant and consistent.

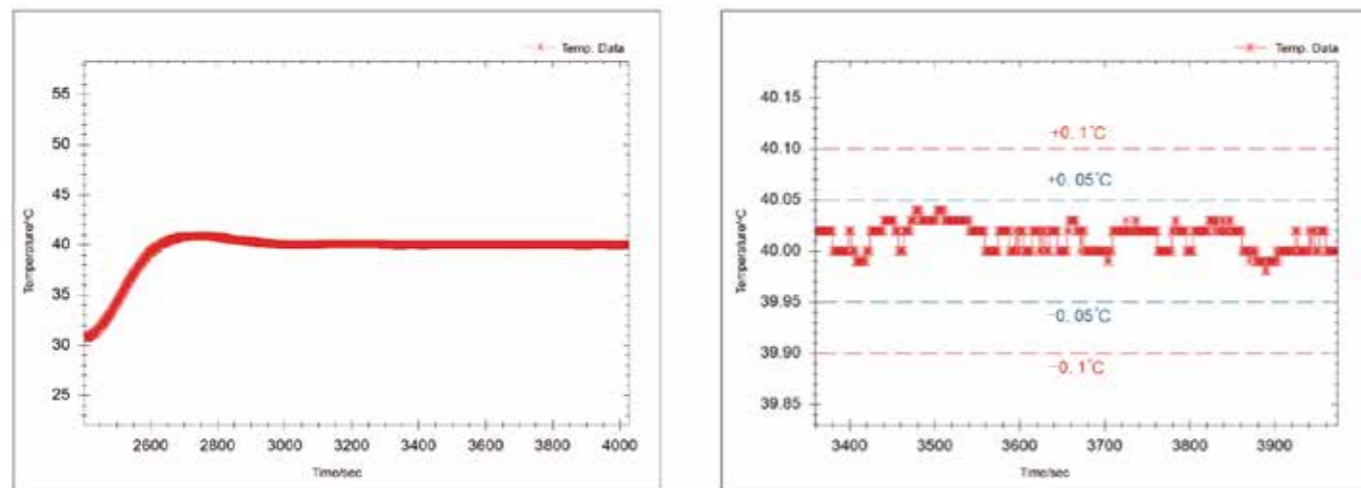

Reliability

Triple protection, more safe to use. Real-time liquid leak protection, intelligent monitoring of Peltier and cavity temperature, over-temperature power-off protection, triple safety protection designs, effectively prevents accidental liquid leakage and dangers caused by over-heating.

HPLC-2025UVD UV-Vis Detector

Specification

Model	HPLC-2025UVD
Light Source	Deuterium(transmission type) and Tungsten lamp
Wavelength Range	190-800nm
Wavelength Accuracy	+/- 1nm
Wavelength Precision	+/- 0.1nm
Linearity	>2.5 AU
Wavelength Calibration	Mercury lamp

Features

Precision

Low LOD

The high-throughput optical path, reference subtraction algorithm, and ultra-precise signal acquisition circuit ensure the detector's excellent sensitivity.

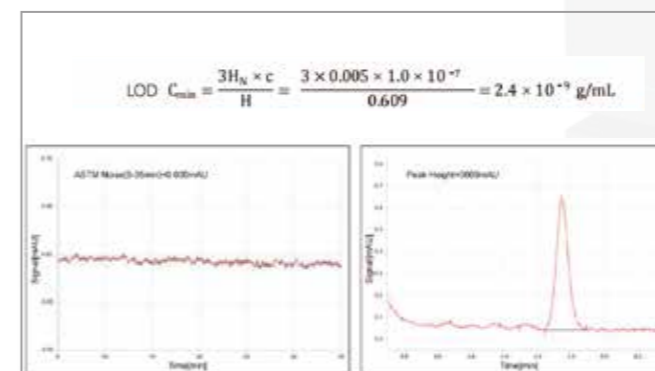

Wide linearity

The UVD covers a wide linear range of 2.5AU, making it easier to analyze high concentration samples.

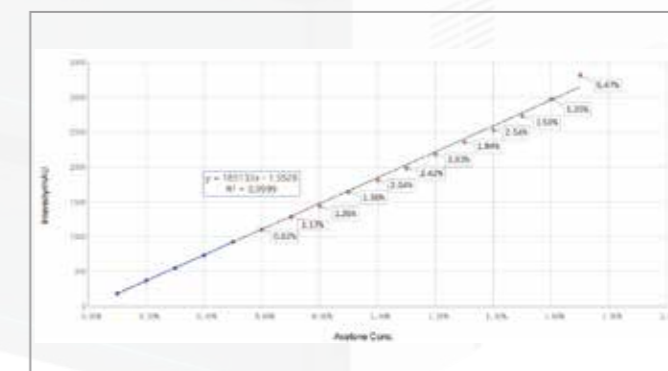

HPLC-2025DAD Diode Array Detector

Reliability

The transmission type deuterium lamp and static light path allow the light source switching without moving of lamp, which is more reliable.



With the design of the optical unit and the light source module, the service life is much longer.



Specification

Model	HPLC-2025DAD
Light Source	Deuterium (transmission type) & Tungsten lamp
Wavelength Range	190-800nm
Slit Width	1nm, 2nm, 4nm, 8nm
Wavelength Accuracy	+/- 1nm
Wavelength Precision	+/- 0.1nm
Linearity	> 2.0 AU
Wavelength Calibration	Holmium glass

Ease of use

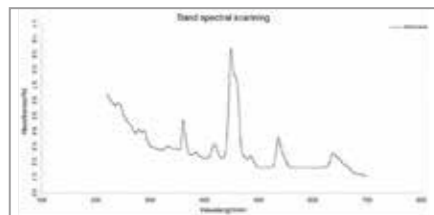

Full-band spectral scanning

A full-band spectral scanning can be performed to easily find the optimal absorption wavelength of the target analyte.

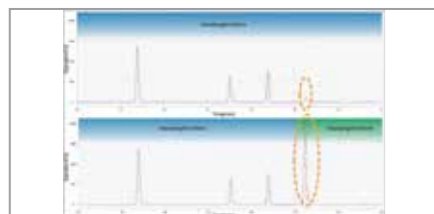

Wavelength time programming

Wavelength can be set for different analytes during different periods, to accomplish the high-sensitivity analysis of complex samples.

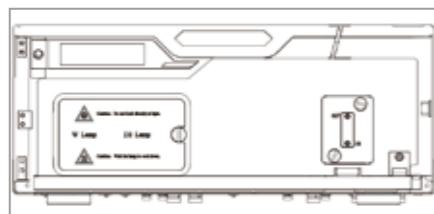

Good maintenance and high safety

Built-in mercury lamp for wavelength calibration.
Over-temperature protection of light source.
Automatic tracking of light energy.
With in-front light source and flow cell and Liquid leak sensor.

Precision

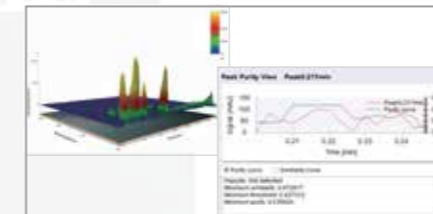

Spectral similarity alignment and peak purity determination are performed for precise qualitative and quantitative analysis.

DAD provides full-spectrum information. The compounds can be identified by similarity comparison in the spectral database. Peak purity determination can be performed in the workstation.

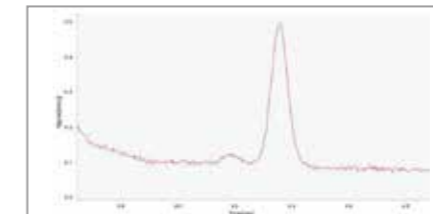

High sensitivity—Close to UV Detector
High sensitivity mode can be performed for low concentration samples, the signal-to-noise ratio of DAD can be reached to the same level of UVD.

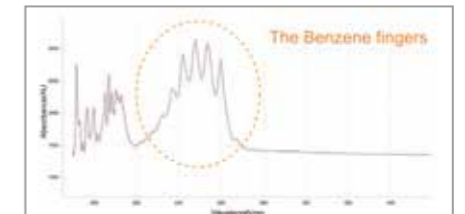

Achieving more accurate inspection data by high-resolution spectra.
When compound detection is performed in high-resolution mode, a finer spectral map can be output for better analysis of complex samples.

Ease of use

Supports 12-channel real-time data collection

Significantly enhance the analysis efficiency by:
Up to 12 wavelengths can be set for real-time detection;
Real-time analysis at a high sampling rate up to 150Hz;
Full-spectrum detection.

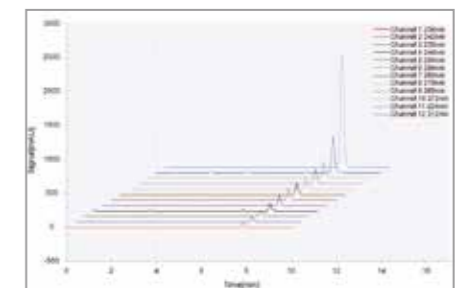

HPLC-2025FLD Fluorescence Detector

Specification

Model	HPLC-2025FLD
Light Source	150W Xe lamp
Wavelength Range(Excitation)	200 to 850nm Zero order
Wavelength Range(Emission)	250 to 900nm Zero order
Detection Sensitivity (Raman peak of water S/N)	S/N ≥ 900 (Baseline method)
Wavelength Accuracy	±3nm
Wavelength Repeatability	±0.5nm

HPLC-2025ELSD Evaporative Light-Scattering Detector

Specification

Model	HPLC-2025ELSD
Noise	≤0.05mV(1.0mL/min 100% Methanol, Gain 1.00)
Drift	≤0.3mV/30 min(1.0mL/min 100% Methanol, Gain 1.00)
Min. Detection Limit	≤5.0×10 ⁻⁶ g/mL(500pg)

HPLC-2025WS Workstation

User-friendly

Ease of use

The workstation interface is flat designed to quickly complete method development, data acquisition, data processing, report editing and printing, etc.



Precision

Powerful data-processing capability

Up to 25 integration events and 3 quantitative calculation methods (external standard method, internal standard method, and normalization method) for complex data.

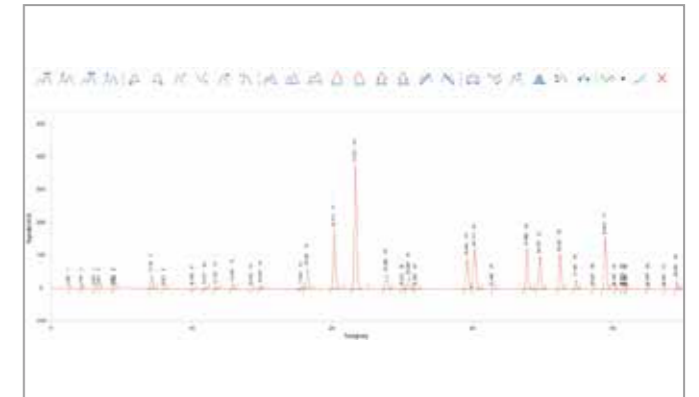

Compliance

Database storage

With the professional database system, the encryption of original files and security of raw data can be guaranteed.

Backup and restore

Backup and restore of data can be easily performed in the workstation, which is convenient for users.

Multi-level user system

Supports customized multi-level system for access to data, ensuring the effectiveness of the system.

Time	Type	User	Description
2022-05-17 11:46:56	Acquisition	admin	Full backup: Single Run Parameters
2022-05-17 11:46:57	Acquisition	admin	Single interface: Single Run Parameters
2022-05-17 11:46:57	Acquisition	admin	After acquisition: Label file (20220517010101.D)
2022-05-17 11:46:57	Acquisition	admin	END Run of Acquisition
2022-05-17 11:46:57	Acquisition	admin	Column Check Step: Integrate Data
2022-05-17 11:46:57	Acquisition	admin	Pump: Stop Purge
2022-05-17 11:46:56	Acquisition	admin	Single: Start running
2022-05-17 11:46:56	Acquisition	admin	Single: Head completed
2022-05-17 11:46:56	Acquisition	admin	Single: Start loading